

Mounting Bars

All models are also available in Threaded Stud Hardware

SAVE-T® Strip Door Hardware

Faster Installation with No Tool Strip Replacement

SAVE-T LOC

Header Mount - 3', 4', 5', 6', 8', & 10' Lengths

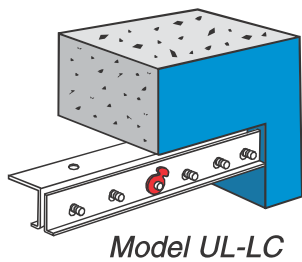

Threaded Stud
Model UL

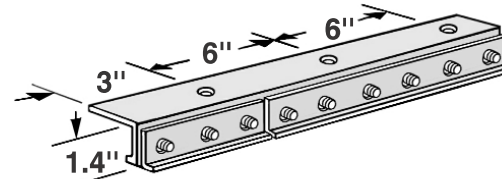

SAVE-T® Hardware is available in galvanized steel, stainless steel & aluminum in both Save-T LOC and Threaded Stud models

SAVE-T LOC

Wall Mount - 3', 4', 5', 6', 8', & 10' Lengths

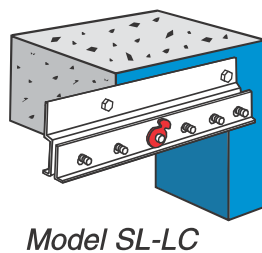

Threaded Stud
Model SL

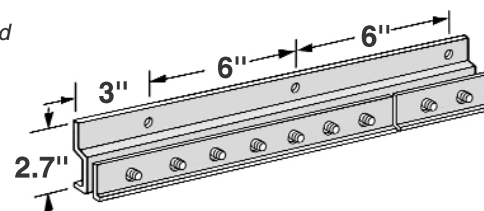

SAVE-T LOC

Universal Header & Wall Mount - 3', 4', 5', 6', 8', & 10' Lengths

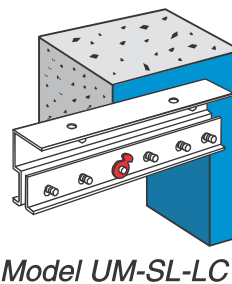
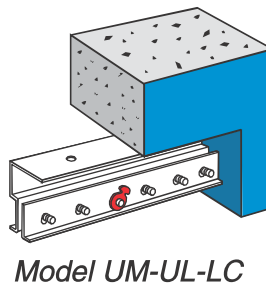

Threaded Stud
Models UM-UL & UM-SL

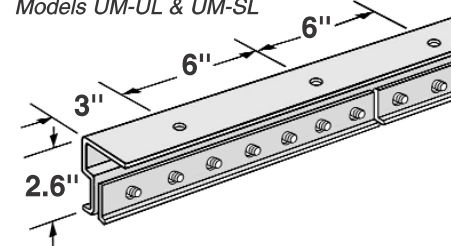

SAVE-T®

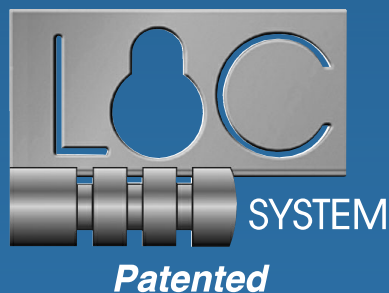

Piano Hinged Header & Wall Mount - 3', 4', 5', 6', 8', & 10' Lengths

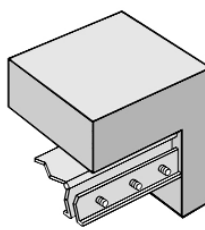
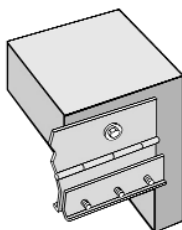

Threaded Stud
Hardware ONLY

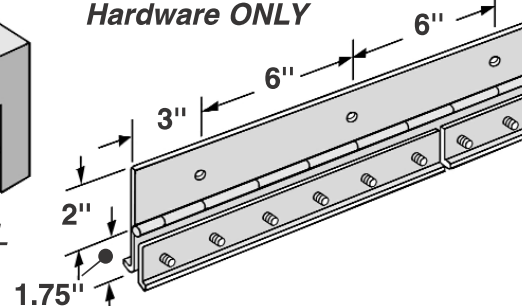

Overhead Door Brackets



Heavy Duty

Standard Duty

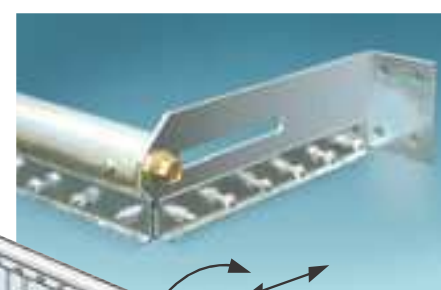

We offer two Save-T Overhead Door Brackets. The "Heavy Duty" design provides superior strength up to 24' wide. Our "Standard Duty" design, a TMI, LLC exclusive, can be easily adjusted or rolled up on doorways up to 11' wide. All brackets are zinc plated.

